

INSTALLATION & OPERATING INSTRUCTIONS



ESTABLISHED 1951

Jetmaster (Pty) Ltd.

Registration No. 1951/001993/07

BUILDER - AFTER READING

THESE INSTRUCTIONS

PLEASE HAND TO OWNER

CONTENTS

1. Installation of Universal model into a new Home

To print this chapter select pages 3 to 6 in the print setup window.

2. Installation of Universal model into existing masonry fireplace

To print this chapter select pages 7 to 9 in the print setup window.

3. Installation of *Hex*, *Lynx* and *Victor* models

To print this chapter select pages 10 to 13 in the print setup window.

4. Installation of *Falcon* and *Heron* models

To print this chapter select pages 14 to 15 in the print setup window.

5. Installation of *Built-in* Barbecues

To print this chapter select pages 16 to 20 in the print setup window.

6. Gas-operated built-in barbecues

To print this chapter select pages 21 to 22 in the print setup window.

7. Installation of free-standing barbecues

To print this chapter select pages 23 to 24 in the print setup window.

8. Operation of *Jetmaster* Fireplace Units (Solid fuel)

To print this chapter select pages 25 to 26 in the print setup window.

9. General Hints

To print this chapter select pages 27 to 28 in the print setup window.

10. Contact Details

To print this chapter select page 29 in the print setup window.

1.1 Size of Unit

For satisfactory heating the size of the **Jetmaster** fireplace unit should be related to the size of the room. If rooms interlead without provision for closing by means of doors or heavy curtains, the entire cubic capacity must be taken into account.

The heating capacities of all units are shown in the catalogue. However, please note that these capacities are conservative and the heating capacity may be increased by up to 25% with a well packed fire.

1.2 Chimney Flues:

- (a) Recommended flue sizes are:

<u>Model</u>	<u>Square or Rectangular</u>	<u>Round</u>
500, 600, 700S, 700D	200 x 200mm	225mm
700 Double-sided	300 x 300mm	350mm
850	200 x 300mm	250mm
1050	200 x 400mm	300mm
1200/1500	350 x 500mm	450mm

The cross-sectional area of the flue must be within 20% of the above-mentioned sizes throughout its length and preferably straight.

- (b) It is recommended that moulded flue liners (square or rectangular) with matching 45E (side or back) bends if required, be used as they provide a perfect flue of the correct size throughout. When liners are used, surrounding brickwork can be reduced to 110mm. Savings on brickwork and plastering offset the cost of the liners.
- (c) Steel square or rectangular flues can be manufactured on request where an exposed flue is desired or where a masonry chimney has not been provided for.
- (d) If flue liners are not used, a straight flue is preferable, but if there are any bends ensure that there is no reduction in area at these points and that there is no mortar blockage. The inside brickwork of the chimney must be plastered to a semi-smooth finish.
- (e) If the flue extends outside a wall the moulded flue must be supported to ground level on a concrete foundation in brickwork.

1.3 Insulation

- (a) When installing, all the built-in surfaces of the **Jetmaster** firebox and smoke gather must be insulated with the fibreglass supplied with the unit. This should be held in position with adhesive tape.

The reason for insulating the unit is not only to reduce heat transfer to the brickwork, but to provide an expansion joint to prevent cracking of masonry or plaster when the unit is in use. **DO NOT** compress the insulation material more than necessary.

- (b) Ensure that the gap between the moulded flue liner and the smoke gather is packed with fibreglass, but make certain that the fibreglass does not impinge on the smoke outlet.

1.4 Special Points to Note

- (a) It is strongly recommended that the **Jetmaster** fireplace unit is built in at the initial stages of brickwork construction. By just leaving an opening for the later installation of the firebox and smoke gather will involve considerably more work and patching.
- (b) Where a **Superjet** i.e. rear fan unit is to be installed, ensure that the electrical connection has been provided for and that the air inlet cover plate allows for easy access to the fan. All electrical connections must be performed by a licensed wireman and connected according to local authority specifications.
- (c) It is better to build the chimney flue slightly too large than too small. Ensure that the chimney height is at least 0,5 metres higher than the roof apex, unless the chimney flue is at least 3 m from the apex, and that the top of the chimney is weathered (see Fig. 1) or a **Jetmaster** cowl is fitted (refer Fig. 8).
- (d) With **thatch - or timber-roofed homes** always ensure that the chimney extends above the apex of the roof by 1 m minimum. If a cowl is necessary, a **Jetmaster** rotating cowl or a spark arrestor should be fitted
- (e) **DO NOT** under any circumstances recess the frame of the firebox more than 150 mm behind the face of the brickwork or plaster.
- (f) The air inlet at the lower front of the firebox **MUST** be left open and unobstructed.
- (g) **Where two or more units are provided for in one structure, ensure that each unit has its own flue right to the top of the chimney.**
- (h) **IMPORTANT:** Combustible materials should not be fitted within 200 mm of the sides of the firebox or 450 mm above the firebox unless adequate provisions are made to insulate such materials.
- (i) A non-combustible hearth must be constructed (tiles, marble, granite, slate etc.) at least 200 mm wider on each side of firebox and at least 400mm to the front. Make sure the air inlet is unobstructed.

Installation of *Universal* model into a new home

Fit a **Jetmaster** cowl
(refer Fig. 8)

110 mm brickwork is adequate
if liners are used.

Fig. 1 - Typical flush installation

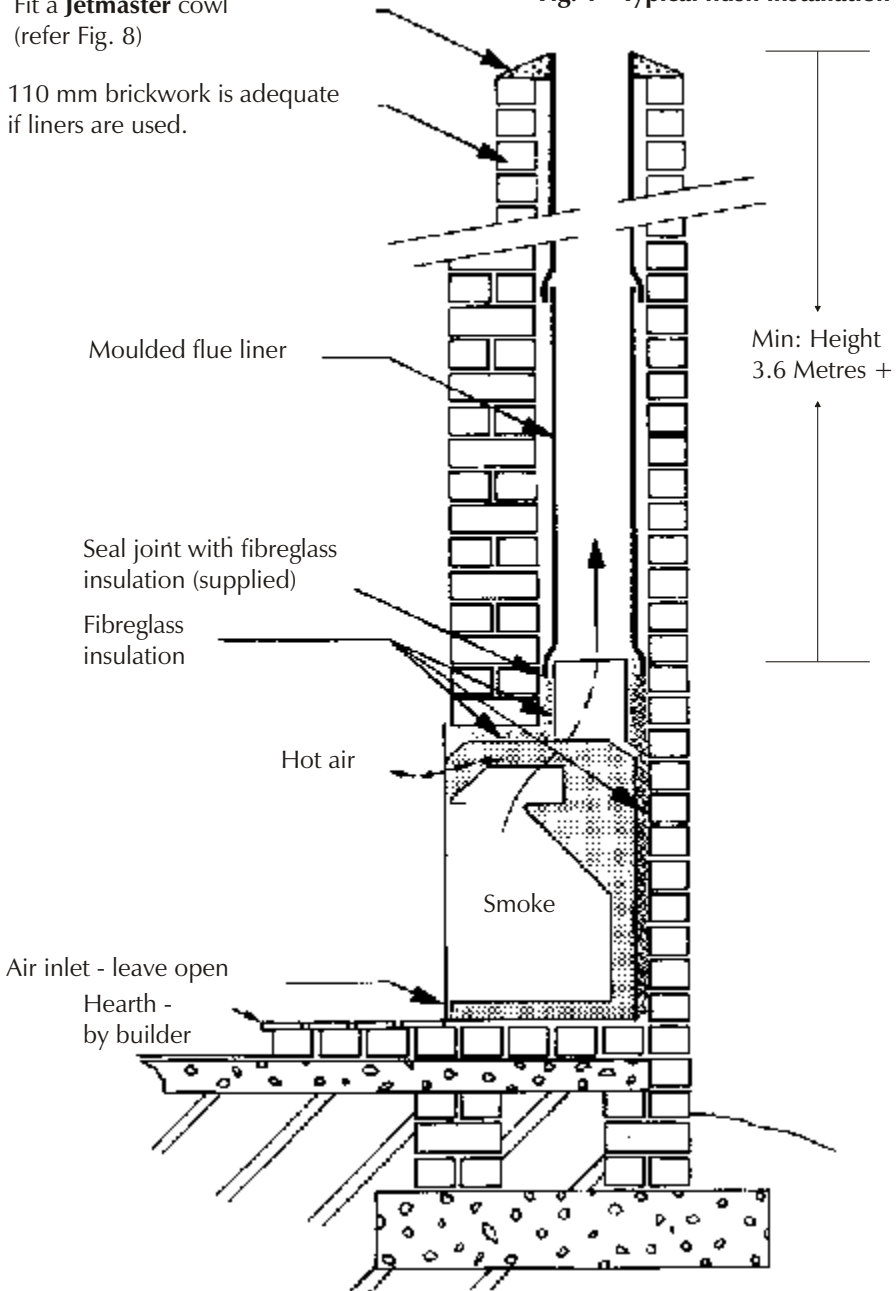

Please read written instructions in conjunction with these diagrams.

Fig. 2 - Recessed installation using optional steel lintel and showing the *Superjet* fan box

Weather top of chimney as shown or fit **Jetmaster** cowl (refer Fig. 8)

110 mm brickwork is adequate if liners are used.

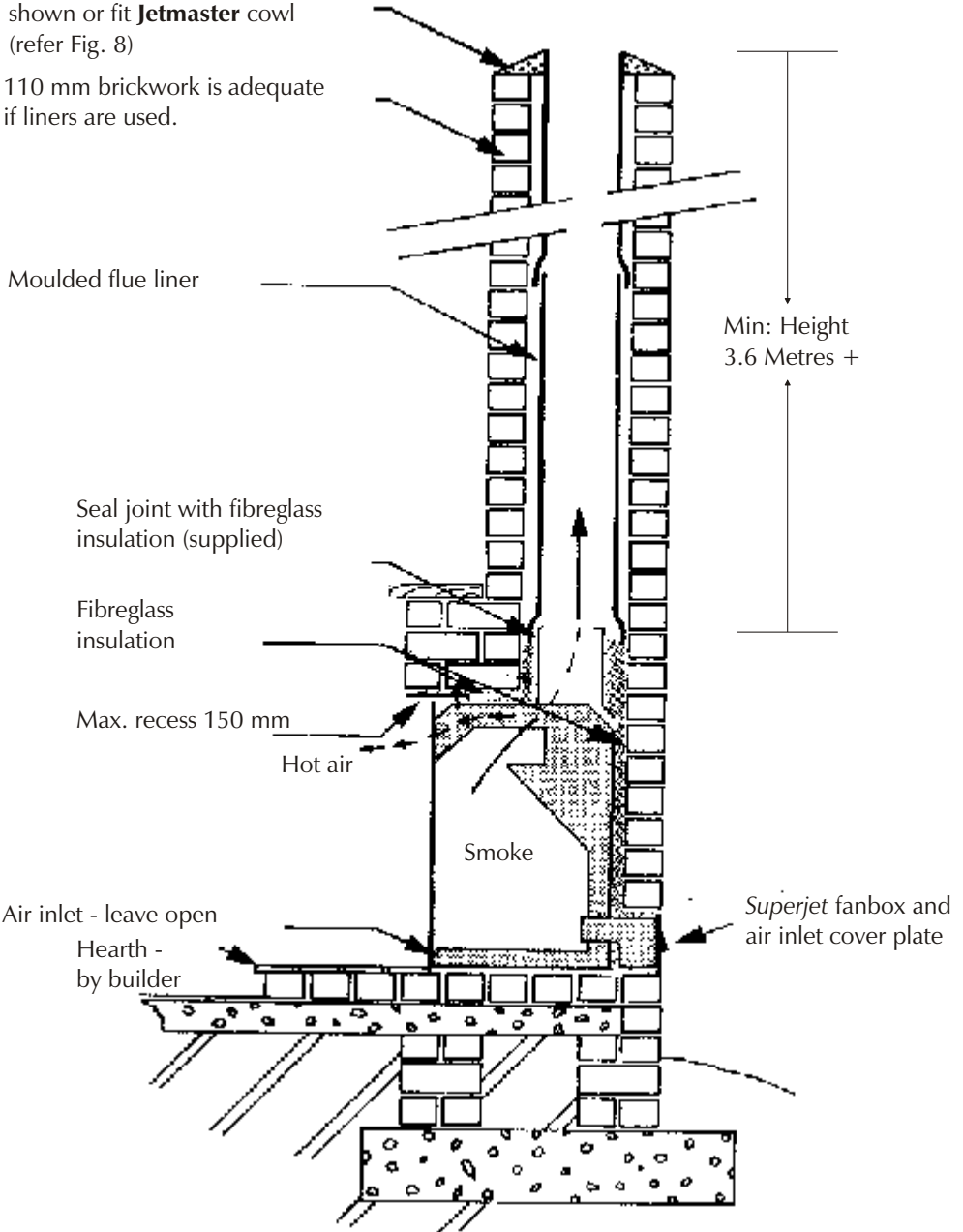

Please read written instructions in conjunction with these diagrams.

Additional heat can be obtained from an existing fireplace by installing a **Jetmaster** unit either from the regular range or custom-built to fit with a minimum of building work.

2.1 Unit size and chimney flue

The size of **Jetmaster** firebox that can be installed into your existing masonry fireplace is determined by the minimum dimensions of the chimney flue.

Minimum flue areas are:

Model	
500, 600	- 300 cm ²
700S, 700D	- 366 cm ²
700 Double sided	- 950 cm ²
850	- 510 cm ²
1050	- 730 cm ²
1200	- 1175 cm ²
1500	- 1475 cm ²

Before installing the firebox, ensure that the flue is of the correct area throughout its entire length.

This can be done by lowering a torch (attached to strong cord) down the chimney.

- 2.2 (a) Recess too large:
If the size of the firebox is smaller than the size of the recess, this can be reduced by laying bricks at the sides and/or back and where necessary between the top of the unit and the underside of the lintel or a plinth can be constructed (refer Fig. 3). Leaving enough room for the insulation.
- (b) Recess too small:
The recess can be made deeper by removing the roll back and smokesheff. If too narrow cut away brickwork at sides and if height is too low, remove the lintel and replace it at the required height.

NOTE: Allow 25 mm all round for the fibreglass insulation.

- 2.3 The two flue outlets must marry up with the existing chimney as indicated in Fig. 3.
- 2.4 Any cracks or cavities in the recess must be repaired and sealed.
- 2.5 Tape the insulation to the back and sides of the **Jetmaster** and slide into the recess, taking care not to snag the fibreglass insulation against the sides.

- NOTE: (a) Do not recess the frame of the firebox more than 150 mm.
 (b) Ensure the smoke outlet openings are not obstructed.
 (c) Air inlet at lower front of unit must not be obstructed.
- 2.6 Seal the firebox into position using masonry and mortar, ensuring that any air leakage around the frame is eliminated. Non-combustible strips may be required as indicated in Fig. 4. Mortar can be packed between the firebox side and brickwork by hand through the damper opening.
- 2.7 **Allow the masonry work to cure for a minimum of four days before lighting a fire.**

Installation of Universal model into existing masonry fireplaces

(Usually installed with bolt-on smoke gather removed)

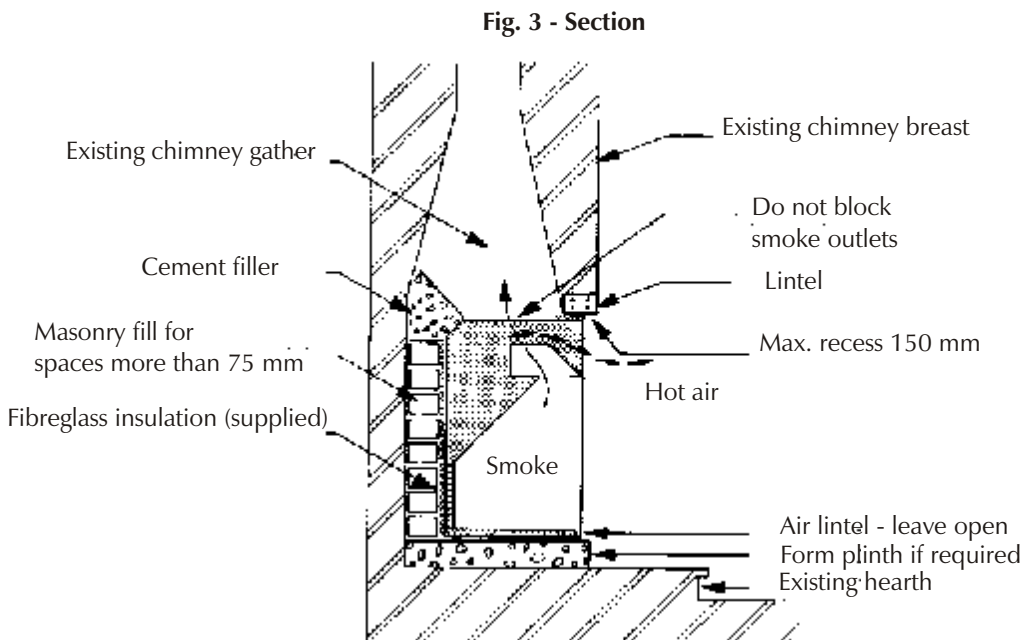

Please read written instructions in conjunction with these diagrams.

Fig. 4 - Plan view

A
Fireplace recess slightly too large (less than 75 mm) - pack with extra layers of fibreglass insulation

B
Fireplace recess too large (more than 75 mm) - use bricks to build up and reduce size

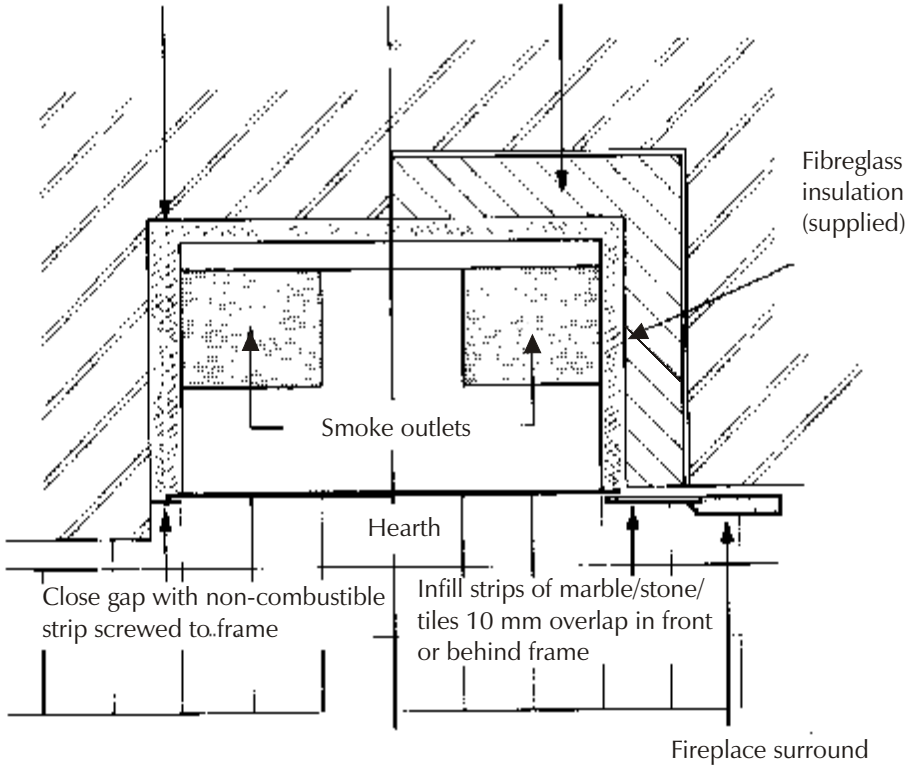

Please read written instructions in conjunction with these diagrams.

- 3.1** Carefully cut a hole through the ceiling in a position **away from any timber beams or brander**, making sure that the opening is approx. 25 mm larger than the steel flue. Use the ceiling escutcheon plate as a template and add 12 mm all round to that dimension.

NOTE: To position the flue between the beams and brander hammer a nail downwards through the ceiling in the roof space.

- 3.2** Remove roof tiles in the immediate area or cut a similar hole through the roofing material.
- 3.3** If a hearth is to be constructed (e.g. in a carpeted room), use a plumb line from the centre of the hole in the ceiling to determine the position of the hearth.
- 3.4** In the case of installing the Victor model, measure the position of the rear securing bracket off the unit and fix the bracket to the wall by means of wall plugs.
- 3.5** Position the fireplace unit and flue section.

NOTE: With the **Hex** and **Lynx** model, ensure that the butterfly damper is at the base and rear of the flue.

- 3.6** The chimney flue must now be flashed at roof level with galvanised iron or lead flashing. (Normally done by a plumber.) If a **Rotating Hex** model is to be installed, the flashing top is circular in shape to allow the steel flue to turn.
- 3.7** Push down the weathering collar over the flue until it covers the top of the flashing by about 50 mm. Seal this against the flue using the black silicone sealer (supplied).
- 3.8** Fit the cowl. In extremely windy areas it may be necessary to secure the cowl to the flue by means of self-tapping screws.
- 3.9** If the flue is on more than one section it is advisable to seal the joint with black silicone sealer (supplied) and secure the sections by means of self-tapping screws. This is **essential** with the rotating **Hex** models.
- 3.10** Insulate the steel flue between the roof and ceiling with the insulation material supplied, binding the fibreglass into position with light-gauge wire meshing (also supplied).
- 3.11** Fix the escutcheon plate to the exposed ceiling to ensure a neat join where the flue passes through.

- 3.12. Ensure flue is of sufficient length (see Fig. 10). Extra flue is available.
- 3.13. After installation paint exposed steel flue, cowl, etc above the roof line with good quality external enamel to protect against corrosion. This will require repainting from time to time.
- 3.14. With rotating Superjet Hex model, fireplace unit and flue rotate through 180E. Ensure that electrical connection is spiral flexible conduit.
- 3.15. Ensure rotating cowl turns freely and safety screw is engaged.

NOTE: THATCH OR TIMBER ROOFS

- (a) Where one of the above models is used in a thatch or timber-roofed home, the space between the steel flue and the thatch should be very well packed with the fibreglass insulation material. **Please ensure that the steel flue is thoroughly insulated.** A galvanised sleeve through the thatch should be provided for as shown in Fig. 6.
- (b) It is advisable to have the top of the steel flue above the apex of the roof. **Do not fit fixed steel chimney cowl.** If wind downdraught is apparent, fit **Jetmaster** rotating cowl.

Installation of Hex, Lynx and Victor models

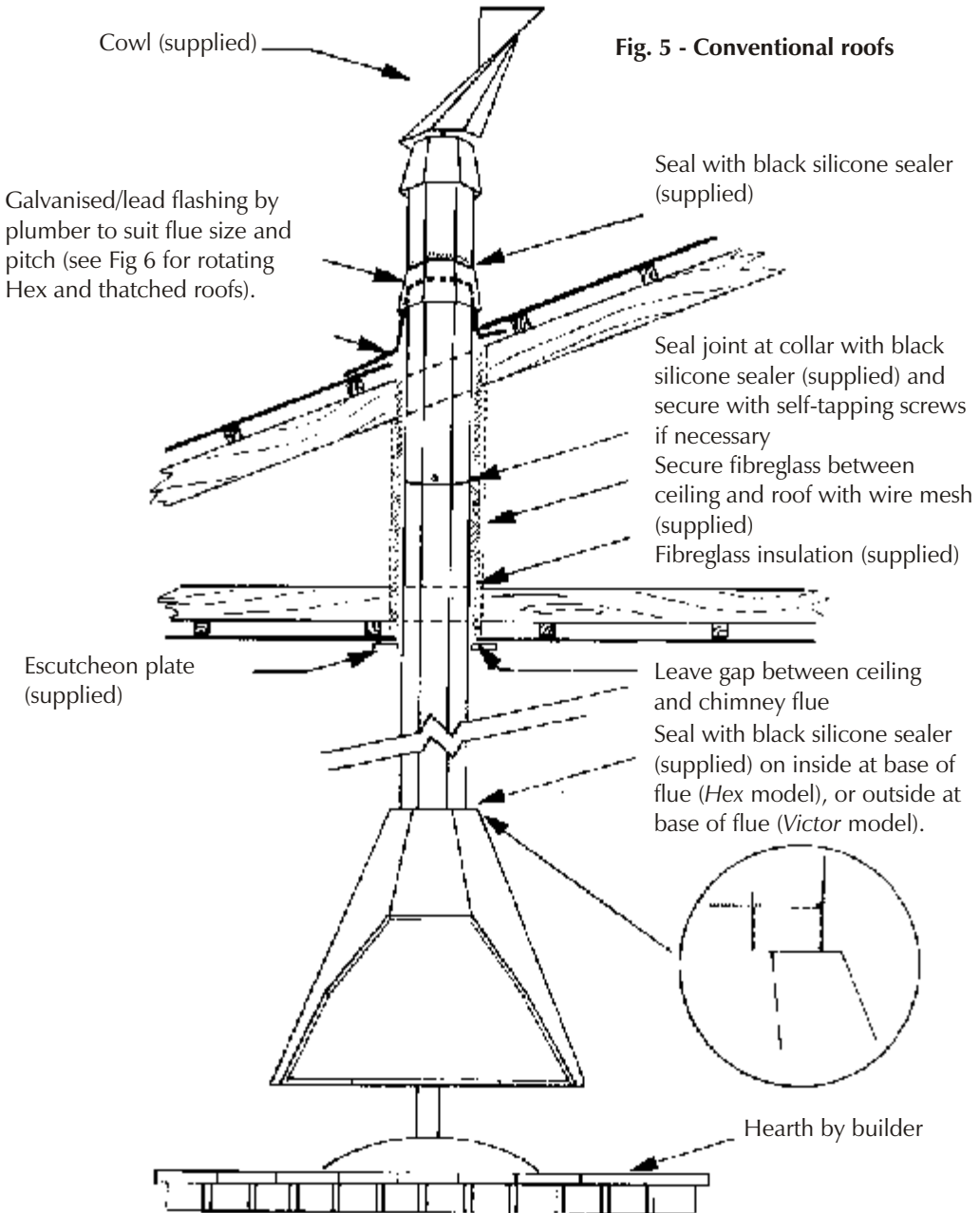

Please read written instructions in conjunction with these diagrams.

Fig. 6 - Thatched or Timber Roofs and Rotating Hex

With thatched or timber roof, omit cowl (supplied) or fit rotating Jetmaster cowl.

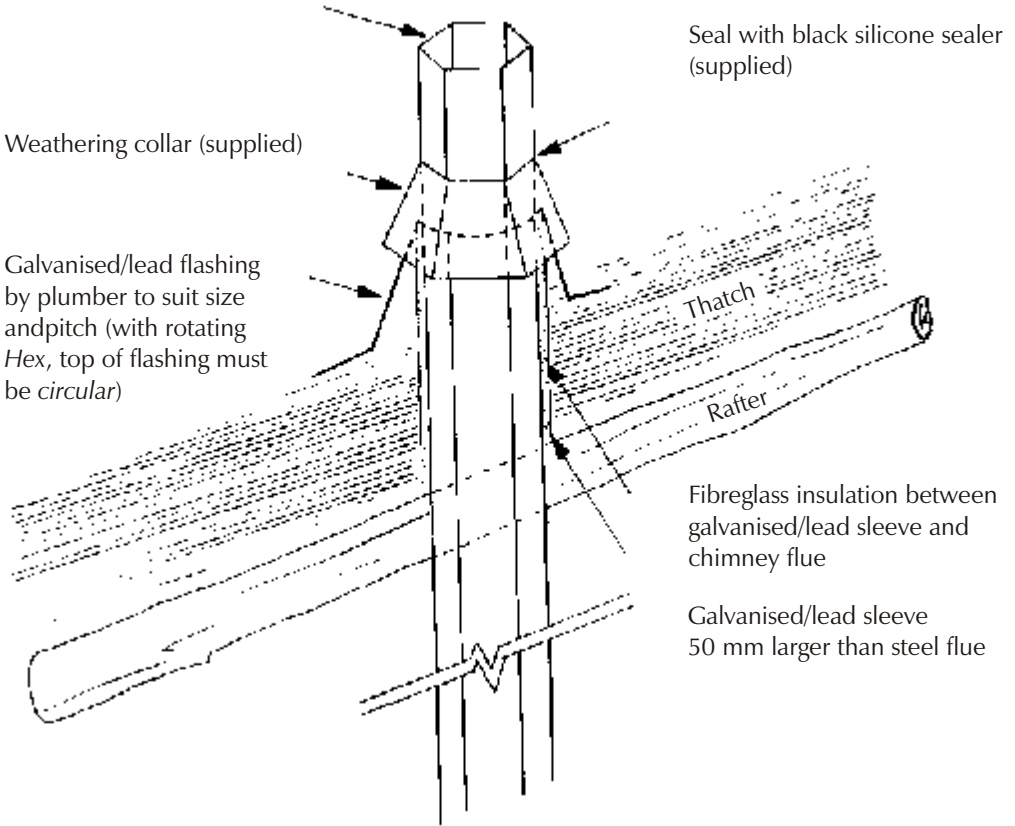

Please read written instructions in conjunction with these diagrams.

- 4.1 These models are usually installed on a raised hearth of non-combustible material.
 - 4.2 It is preferable to install these units into a masonry chimney with **Jetmaster** moulded flue liners. Alternatively, a steel flue can be supplied at extra cost. This is merely bolted against the wall by means of securing brackets. The steel flue is then sealed at roof level in the same way as the Victor model, referred to previously (see Fig. 5).
 - 4.3 The steel flue elbow is designed for 110 mm or 220 mm wall thickness. Select the correct end and fit to the unit.
 - 4.4 Tape the fibreglass supplied to the back of the unit to reduce heat transfer to the brickwork, Excess can be trimmed after installation.
 - 4.5 Position the unit against the wall and prop the base to suit the height of hearth required. Heron model requires air inlet to be built into hearth.
- NOTE: (a) In the case of a facebrick wall the unit can be set against the brickwork and the elbow built in.
(b) In the case of a plastered finish wall, the unit should be set slightly proud of the stock brickwork and the plasterer should then plaster up to and slightly behind the back of the unit.
- 4.6 The brickwork chimney can then be built ensuring that the internal size of the flue is not less than the size of the elbow outlet throughout its length (refer 1.2. *chimney flues*)
 - 4.7 The top of the chimney stack must be weathered as shown or a **Jetmaster** cowl fitted (refer Fig.8).

Installation of Falcon and Heron models

Fig. 7

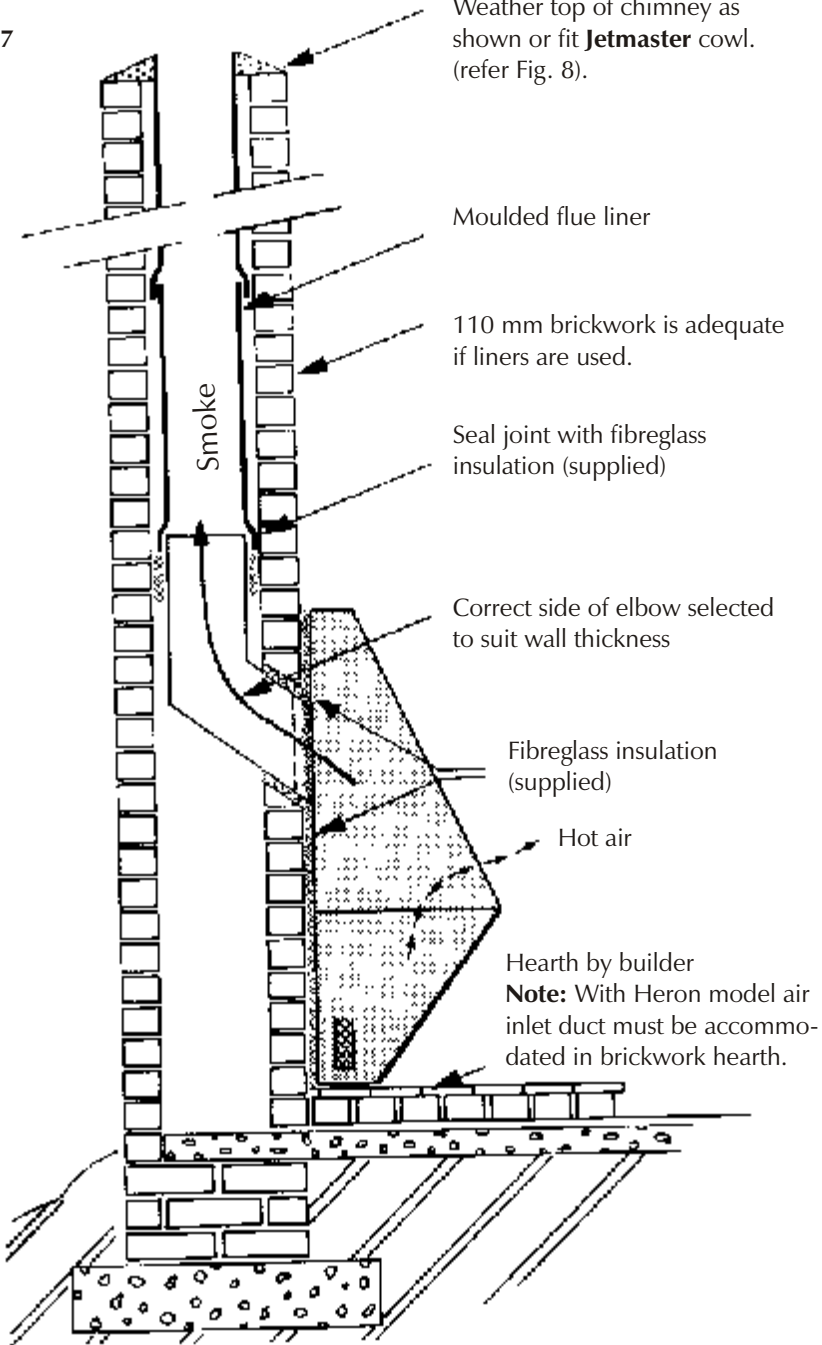

Please read written instructions in conjunction with these diagrams.

General

- 5.1 Please refer to figures 1 to 3 in addition to the written instruction.
- 5.2 The **Jetmaster** BIB unit should preferably be built in at the initial stages of construction. Later installation of the BIB results in more and unnecessary work and patching. When installing the 1500 or 1200 barbecue box, the support pins for the lower door must remain free to move .
- 5.3 The face of the unit should not be recessed more than 150 mm behind the face of the brickwork or plaster.
- 5.4 When installing the barbeque, choose a comfortable height for the grilling surface, based on the height of the person who will usually be operating it. If this is not known, a height of approximately 1000 mm to 1 200 mm from finished floor level to the grilling surface is generally suitable.
- 5.5 It is preferable to support the 1500 and 1200 Super De Luxe models primarily along their bottom side and back edges. If most of the weight of these units is taken centrally, the base of the barbecue box may tend to bow upwards.
- 5.6 If storage space is required beneath the barbecue box for chopped wood, utensils, etc, the box should be supported on pre-pressed concrete lintels. Positioned directly under and extending beyond the sides of the box to rest on the supporting structure, these lintels will take the weight of the brickwork chimney above. Refer to Fig. 8.
- 5.7 A grill is attached to the back plate of the motor box. Where feasible this should be connected to an outside vent, such as a small pipe or similar. This will provide a through draught, thereby reducing the build-up of excessive heat in the motor box.

Insulation

- 5.8 In order to reduce heat transfer from the barbecue box to the surrounding brickwork and provide an expansion joint to prevent cracking of masonry or plaster once the unit is in use, your **Jetmaster** barbecue box and smoke gather must be insulated with fibreglass. Care has to be taken that the fibreglass does not get into the inside of the smoke gather where it will disturb the smoke flow. Refer to Fig. 8.
- 5.9 Insulation material should not be compressed more than necessary. A convenient material can be used to hold the fibreglass in place during construction, if needed.

5.10 Combustible materials should not be fitted closer than 200 mm to any side of the barbecue box, or within 450 mm of the top of the barbecue box, unless adequate provision is made to insulate such materials.

Fig. 8 - Installation of built-in barbecues

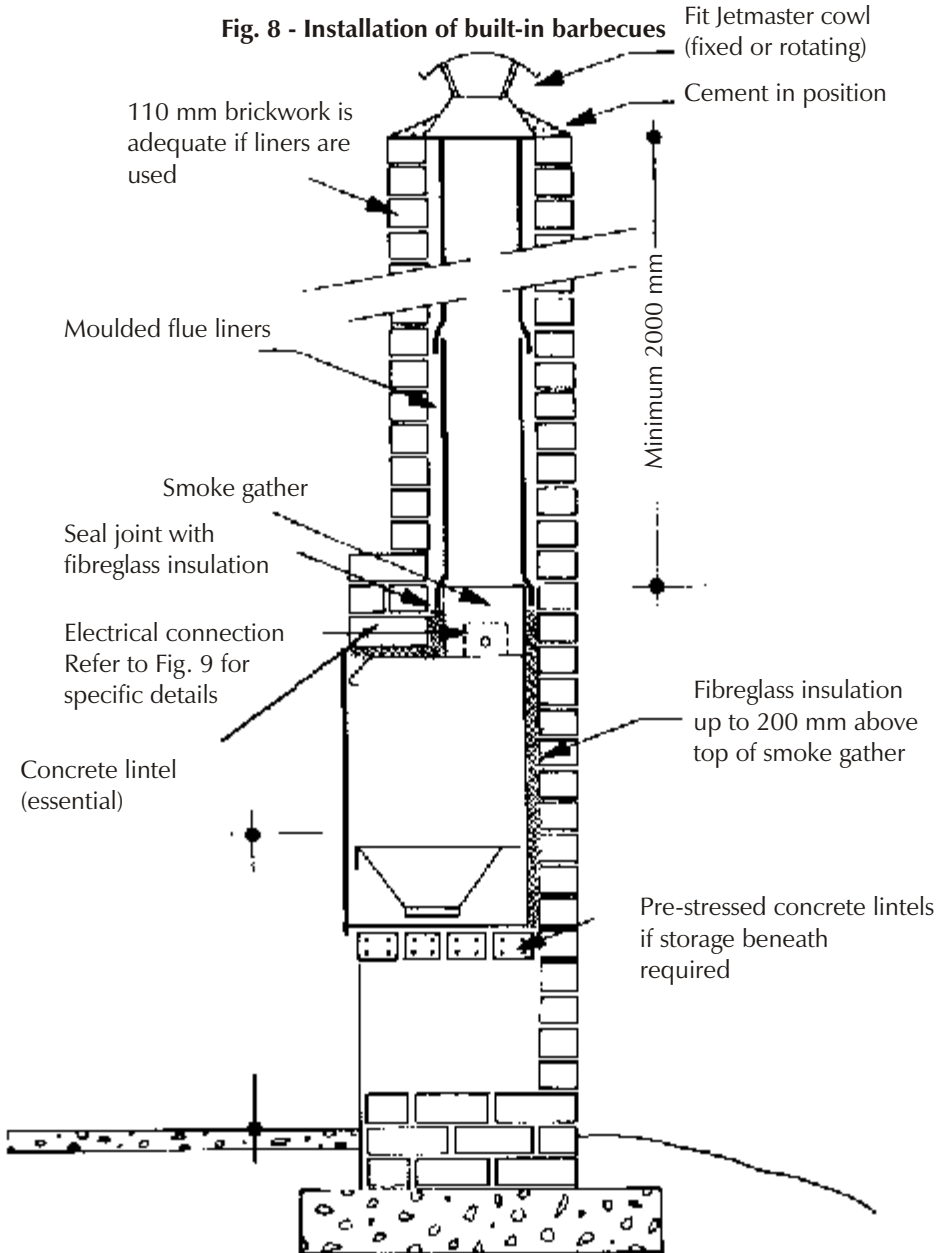

Please read written instructions in conjunction with these diagrams.

Electrical connection

- 5.11** Electrical work should only be carried out by a qualified electrician.
- 5.12** Please refer to Fig. 9 in addition to the written instructions.
- 5.13** All built-in models require a 220 V electrical connection for the light fitting forming part of the outer barbecue box. The light fitting must be earthed.
- 5.14** A light switch is needed for the 700 Std, 1000 Std, 1200 Std and 1000 De Luxe. Use insulated stove wire (supplied) to connect.
- 5.15** 1500 and 1200 Super De Luxe models require internal wiring. A two way switch inside the motor box is used to operate the light as well as the 220 V spit motor. The spit motor must be earthed.
- 5.16** For connecting each light fitting, a length of 3-core electrical stove wire is supplied with each barbecue box. The sheath is fitted over the wire where it passes through the wall of the barbecue box.
- 5.17** If the electrically-driven spit is incorporated into the 1000 De Luxe, a suitable plug point to which the 220 V motor can be connected should be provided.
- 5.18** The spit when fitted should never be turned by hand as you will strip the gearing inside. To turn the spit turn the motor on and then off.

Fig. 9 - Electrical connections

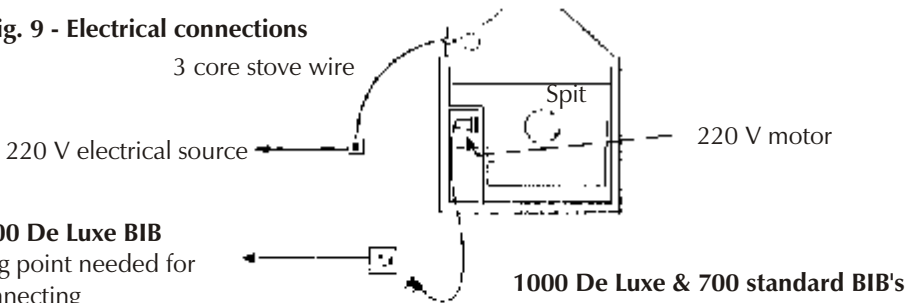

1000 De Luxe BIB

Plug point needed for connecting light duty motor

1000 De Luxe & 700 standard BIB's

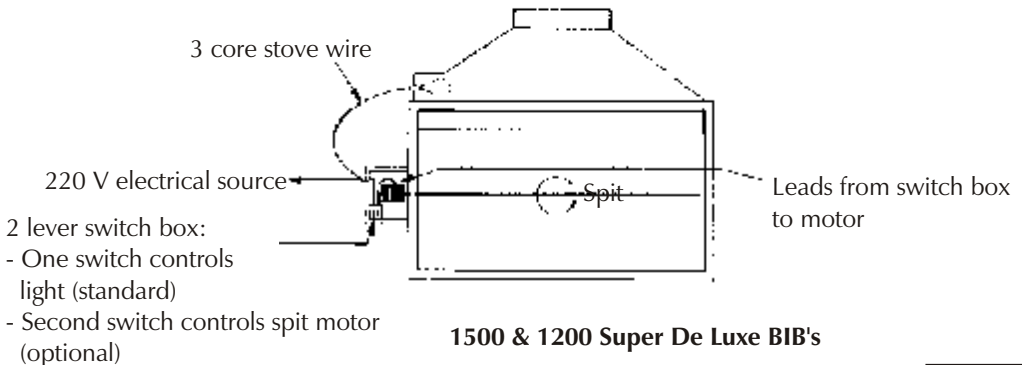

2 lever switch box:

- One switch controls light (standard)
- Second switch controls spit motor (optional)

1500 & 1200 Super De Luxe BIB's

Please read written instructions in conjunction with these diagrams.

Chimney flues and flue liners

- 5.19** Recommended flue sizes for the different models are:
1500 & 1200 Super De Luxe: 500 mm x 350 mm;
1000 De Luxe/Standard: 400 mm x 200 mm;
700 Standard: 300 mm x 200 mm
1200 Standard: 300mm x 300mm
- 5.20** Build the chimney flue slightly larger than smaller if you cannot adhere to the recommended size. The internal flue size should under no circumstances be smaller than the dimension of the smoke outlet at the top of the gather.
- 5.21** The use of a Jetmaster moulded flue liner will ensure a perfect flue of the correct size throughout. When such a liner is used, surrounding brickwork can be reduced to 110 mm. Savings on brickwork and plastering the inside of the chimney offset the costs of the liners.
- 5.22** The inside brickwork of the chimney needs to be plastered if a flue liner is not used.
- 5.23** Ensure that the flue damper is erected the right side up.
- 5.24** The chimney flue should be at least 2 meters long to provide and adequate draught, thereby preventing smoke from being expelled to the front of the barbecue.
- 5.25** The level of the top of the chimney varies depending on roof type. Refer to Fig. 10.
- 5.26** In the case of a thatch or timber-roofed home always ensure that the chimney extends at least 1 m above the apex of the roof, irrespective of the distance between chimney and roof apex. Only a **Jetmaster** rotating cowl should be fitted. Never fit a fixed cowl in the case of a thatched roof.
- 5.27** A **Jetmaster** cowl (fixed or rotating) should be fitted to the top of the chimney to prevent rain from entering the flue and causing unnecessary corrosion of the barbecue box. This cowl also prevents downdraughts and resultant smoking problems. In areas where there is high corrosion, repaint the unit at least once a year with **Jetmaster** heat resistant paint.
- 5.28** In multiple installations, each barbecue unit should have its own flue extending to the top of the chimney.

Fig. 10 - Chimney heights

Roof pitch less than 10°

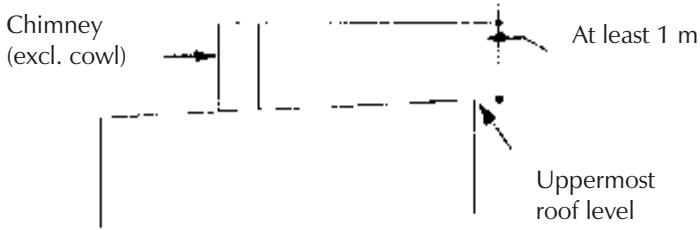

Roof pitch of 10° or more

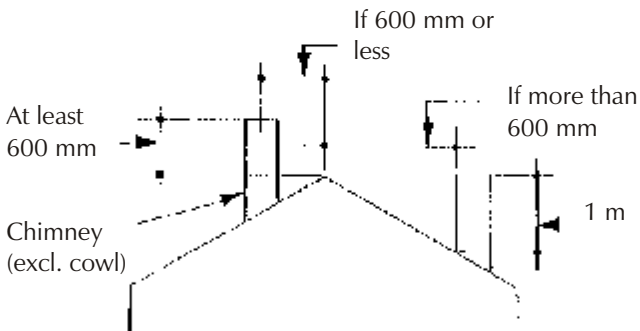

Opening or adjacent structure

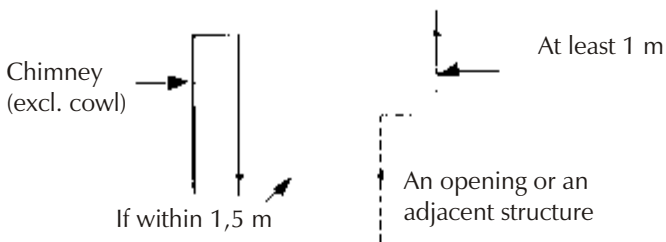

6.1 Gas converted models 1000, 1200, 1500 De Luxe and 700 Standard

A Jetmaster gas grill can be incorporated into a 700 Std, 1000, 1200, or 1500 De Luxe models. These grills are designed for use in these models exclusively.

Gas provides a very safe form of energy but, as with other fuels, should be treated with respect. Gas installations should be carried out by a qualified person. Incorrect installation will not only invalidate the guarantee, but could also prove to be dangerous.

The SABS lays down specific regulations with regard to the installation and handling of gas cylinders. This information is available from Jetmaster's technical department.

The instructions which follow are general in nature and some variation may be necessary to suit individual installation needs. Jetmaster cannot accept responsibility for difficulties which may arise as a result of significant deviations from these instructions. It is therefore advisable to consult Jetmaster or any of its distributors prior to installation if such deviations are planned.

6.2 Installation of gas grill (48 kg cylinder only)

A copper tube is provided to convey the gas from the cylinder to the gas grill.

- 6.3** Choose a suitable entry point in the outer barbecue box for the copper pipe. This point can be either at the back of the box, higher than 20 mm off the base of the fire box but no higher than 40 mm, or through the base itself
- 6.4** Drill a hole at least 10 mm in diameter through the outer box and its supporting brick work. If the pipe work has to go through concrete/brick then the hole must be sleeved and the copper pipe pushed through the sleeve.
- 6.5** Position and fix the gas cylinder in an upright position so that it cannot be knocked over. The gas cylinder should be fixed in a convenient place, not close to drains or underneath a window, and where there is adequate ventilation at all times. The cylinder should never be stored in an under ground facility such as a basement, near heating sources or power points, or alongside other flammable fuels or materials
- 6.6** Run the copper tube from the gas cylinders to the gas braai making sure that the end of the copper tubing that has to be pushed through the wall is sealed with tape, so that dust and dirt cannot get into the pipe.

- 6.7** Connect one end of the copper tube to the flexible hose and regulator, these parts are all supplied with the gas braai. The regulator should be fitted to the gas cylinder by means of a nut which has to be turned anti-clockwise to screw into the gas bottle. Check that the rubber seal is not damaged or perished and ensure that the regulator is correctly orientated. If the plastic cap on the regulator faces upwards, liquids may collect on the regulator resulting in internal components rusting and consequent malfunctioning.
- 6.8** The pipework must now be purged prior to connecting to the gas braai to remove any rubbish that might be collected in the copper pipe. It is advisable to form a loop of copper tube to allow for movement before connecting to the gas compression fitting on the left hand side of the grill. This can be done with two spanners taking care not to over tighten the nut. Once connected carefully push the grill into the braai box making sure you do not kink or damage the copper pipe.
- 6.9** Test all joints for leaks by opening the gas cylinder valve and apply a solution of soap and water to the joints making sure that they are dry when finished testing. Never use a flame to test for leaks.
- 6.10** It is essential to provide adequate ventilation for indoor installations. A free flow of air into the room is needed to compensate for air consumed in burning of the gas, as well as a flue for expelling the fumes when operating the grill.

- 7.1 Please refer to Fig. 5 and Fig. 6 in addition to the written instructions.
- 7.2 The free-standing barbecue can either be supported by a pedestal, or wall-mounted by means of a rear securing bracket and wall plugs.
- 7.3 If the free-standing barbecue is to be installed under roof, check that the position you have chosen is not directly underneath timber beams or bracing. By hammering a nail downward through the ceiling between beams and bracing a mark point can be established in order to position the flue section and barbecue unit.
- 7.4 Bear in mind that steel flue pipe can get hot after prolonged heating. No combustible materials should therefore be permitted to come too close to the flue.
- 7.5 To install the steel flue, carefully cut a hole 25 mm larger than the flue dimension, through the ceiling. An easy way to achieve this dimension is to use the ceiling escutcheon plate as a template and add 12 mm all round.
- 7.6 If more than one flue section is used, the sections should be secured by means of self-tapping screws and the joint sealed with black silicone sealer.
- 7.7 The section of the steel flue between the ceiling and roof should be insulated with fibreglass, using the light-gauge wire meshing provided to bind it into position.
- 7.8 The escutcheon plate, fixed around the flue, provides a neat finish where the flue passes through the ceiling.
- 7.9 An opening for the chimney to project through the roof can be created by removing the roof tiles in that area, or by cutting a hole - similar to that of the ceiling - through the roofing material.
- 7.10 The chimney flue should be flashed at roof level, using either galvanised iron flashing from Jetmaster, or lead flashing only. This is normally done by a plumber. Acrylic flashing (liquid flashing) is not recommended. This is followed by pushing down the weathering collar over the flue until it covers the top of the flashing by approximately 50 mm, and sealing it against the flue with black silicone sealer fitting the cowl. See 3.13 and 3.14.

In extremely windy areas it may be necessary to secure the cowl to the flue. This can be done by means of self-tapping screws.

- 7.11** In the case of thatched or timber roofs, the space between the steel flue and the thatch should be very well packed with fibre-glass insulation material. Provision should also be made for a galvanised sleeve through the thatch (refer to Fig. 6), and the top of the steel flue should extend above the apex of the roof. A fixed steel chimney cowl should never be used. A Jetmaster rotating cowl should be fitted.

8.1. Flue Damper Control

The damper control varies the size of the throat in the fireplace, serving two purposes:

- (a) Provides control over the burning rate of the fire and therefore the consumption rate of the fuel.
- (b) Reduces the heat-loss up the chimney, thereby improving efficiency.

The fire in the **Jetmaster** is lit with the damper fully open to promote maximum draw from the fire. When the fire is burning well the damper can be closed down (using the poker provided) to a position that will allow the fire to burn at the desired rate without smoking. This position will be determined by the draw on the chimney, the type and size of the fuel being burned and the desired size of the fire.

NOTE: Open position of damper

- (a) *Universal* models - forward (handle L/H side)
- (b) *Hex* models - damper handle vertical (at rear of flue)
- (c) *Heron* models - rear (handle middle)
- (d) All other models - to rear (handle centre)

Because each chimney has its own peculiarities, the damper should be used as best suits your chimney. It should never be closed so far as to cause the least trace of smoke in the room.

8.2 Lighting the fire (Solid fuel)

- (a) Superjet (rear blower) and Jetgrate (portable front blower) models:
 - Ensure that grate is right back against the back-plate.
 - To lay the fire, crumple sheets of dry newspaper, place dry split wood criss-cross on top of the paper, leaving plenty of air space between the pieces.

DO NOT add solid fuel (wood) at this stage.

NOTE: A firestarter may be used in place of the above procedure.

- Before lighting, open damper fully (refer Point 1).
- Light the paper or firestarter and switch on the fan.
- When the wood is burning well, slowly add fuel, limiting the quantity so that the flames are kept alive all the time.
- With the grate fully fuelled and the fire burning brightly (after approx. 40 mins.), the fan can be switched off. (Removed in the case of the **Jetgrate** to prevent heat damage).

- At this stage the damper can be closed down to a suitable position (refer point 1). When further refuelling is required, ensure that the fan is switched on and the damper opened.
- If overnight burning is required ensure that the grate is fully fuelled and that the fan is switched off. In the morning, start the fan, and when the fire is burning brightly, slowly add new fuel.

NOTE: Use only dry logs.

(b) Logpan models (for woodburning only):

- Ensure that the logpan is right back against the backplate.
- To lay the fire, crumple sheets of dry newspaper, place dry split wood criss-cross on top of the paper, leaving plenty of air space between the pieces.

NOTE: A firestarter may be used in place of the above procedure.

- Before lighting, open damper fully (refer point 1).
- Light the paper or firestarter.
- When the wood is burning well, close down the damper to a suitable position (refer point 1). When further refuelling is required it may be necessary to open the damper.

IMPORTANT: Ash must be allowed to build up in the logpan to promote good burning and efficiency. Removal of some of the ash is only necessary when spillage occurs. This will depend on the extent of usage of the fireplace but should not be more often than approximately every six weeks.

NOTE: Use dry logs only.

(c) Basket grate and ashpan models:

- Operation is the same as logpan models above, except that the ash need be removed as necessary by sliding out the ashpan from under the grate for ash disposal. Allowing the ash to build up into the grate will cause the bottom of the grate to disintegrate over a period of time.

- 9.1. **Jetmaster** heat-resistant black touch-up paint is available direct or from distributors to keep your unit looking at its best.

Alternatively black stove polish may be used.
- 9.2. If the fuel you are burning tends to splatter, the use of a firescreen - and there is a **Jetmaster** screen available - is recommended.
- 9.3. It is essential before lighting the fire that a window or ventilator on the windward side be opened slightly to pressurise the room, ensuring the fireplace will not smoke and provide sufficient air to support combustion.
- 9.4. Chimney pots are frequently the cause of smoking problems and we therefore recommend rather the use of a **Jetmaster** chimney cowl to prevent downdraught.
- 9.5. Wet wood that is unseasoned will not burn efficiently and will more than likely cause smoking in excess of permitted emissions allowed in smoke-controlled zones.
- 9.6. Hardwoods are better for open fires than softwoods (pines, etc. which burn too fast and spit). A split log will catch and burn better than a round log. Wood should have been stored (seasoned) in a dry but ventilated place for a year before burning. Green (freshly cut) wood contains around 50% moisture. Heat from the fire has to drive this off as steam before the wood can burn effectively. This heat is lost in the formation of steam. Apart from burning your wood in an efficient appliance, burning seasoned wood is the greatest step towards efficiency. Air-dried seasoned wood has about 20% moisture content; this reduction makes a tremendous difference to the heat output of the fire.
- 9.7. Note that the grate options for burning wood or gas are removable and can be changed for the use of different fuels at any stage.
- 9.8. Please ensure that rotating cowl pin and bush are greased at least once prior to every winter season.
- 9.9. All steel exposed above roof level must be painted with enamel paint to minimise corrosion.

9.10. Gas

Gas is a very safe form of energy but, as with other fuels, must be treated with respect. All **Jetmaster** gas barbecues operate off low-pressure regulators.

- 9.11. Only suitably qualified persons should install your gas burner.
- 9.12. The SABS lays down specific regulations with regard to the installation and storage of gas cylinders. This information is available from our technical department.
- 9.13. To test that products of combustion do not enter the room, hold a lighted match directly above the fire box opening. If the match extinguishes, products of combustion are being drawn into the room. This will cause a strong smell and could also be harmful to your health. To correct, open damper slightly and if still not satisfactory check for chimney downdraught.
- 9.14. Connecting and changing of cylinders should be carried out by a suitably qualified person. Your local dealer will deliver and connect.
- 9.15. All cylinders not in use or considered empty should have the valves tightly closed.



ESTABLISHED 1951

Jetmaster (Pty) Ltd.

Registration No. 1951/001993/07

JETMASTER (PTY) LTD

**P.O. BOX 43178, INDUSTRIA 2042, SOUTH AFRICA
5 LONGDALE LOOP, LONGDALE, JOHANNESBURG**

TEL: (011) 474-2100/4

FAX : (011) 474-2144

EMAIL: jetmaster2@argent.co.za

www.jetmaster.com



Click on our logo to
visit our website.



Click on this link to
e-mail us with queries